

The Latest Status of Design Patent

CNIPA



CONTENT



1

Latest Statistics on Design Patents

2

Amendment to Patent Law about Design



Latest Statistics on Design Patents

1. Latest Statistics on Design Patents

Design Applications Received by the CNIPA (2018-2022)

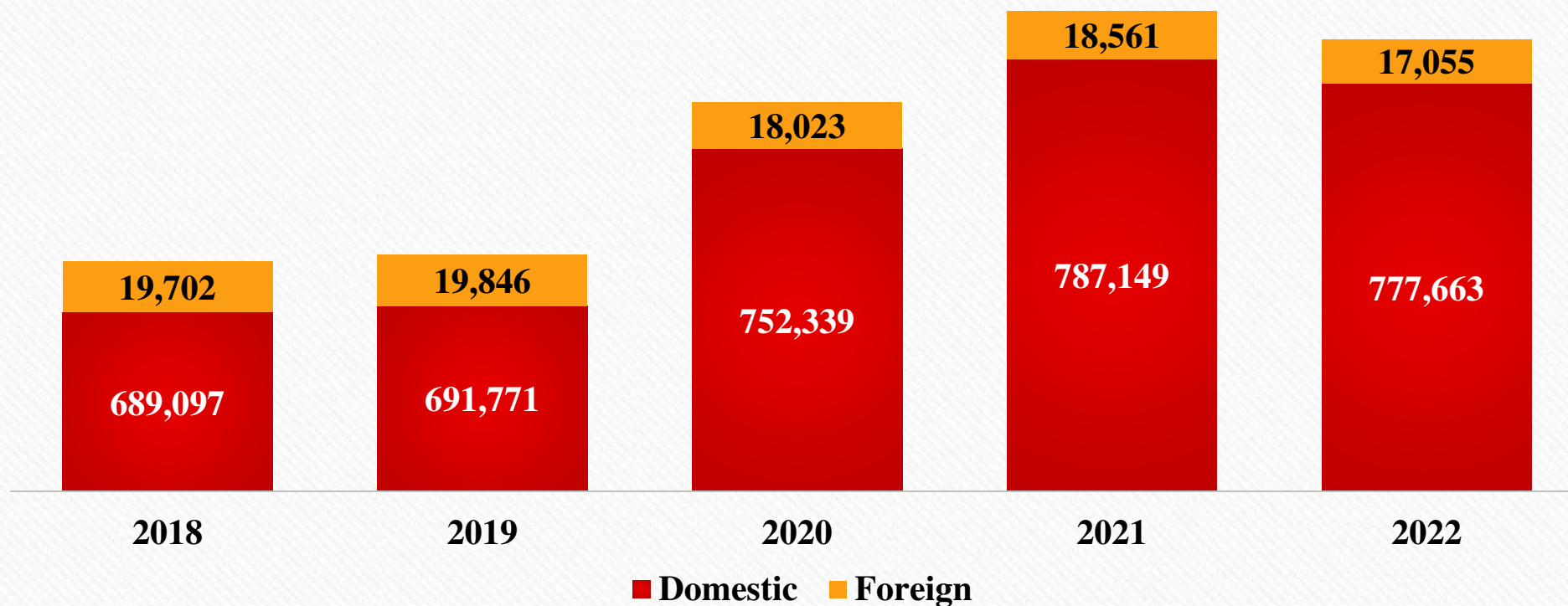

1. Latest Statistics on Design Patents

Top 10 Foreign Countries Applying Design Patents in China (2022)

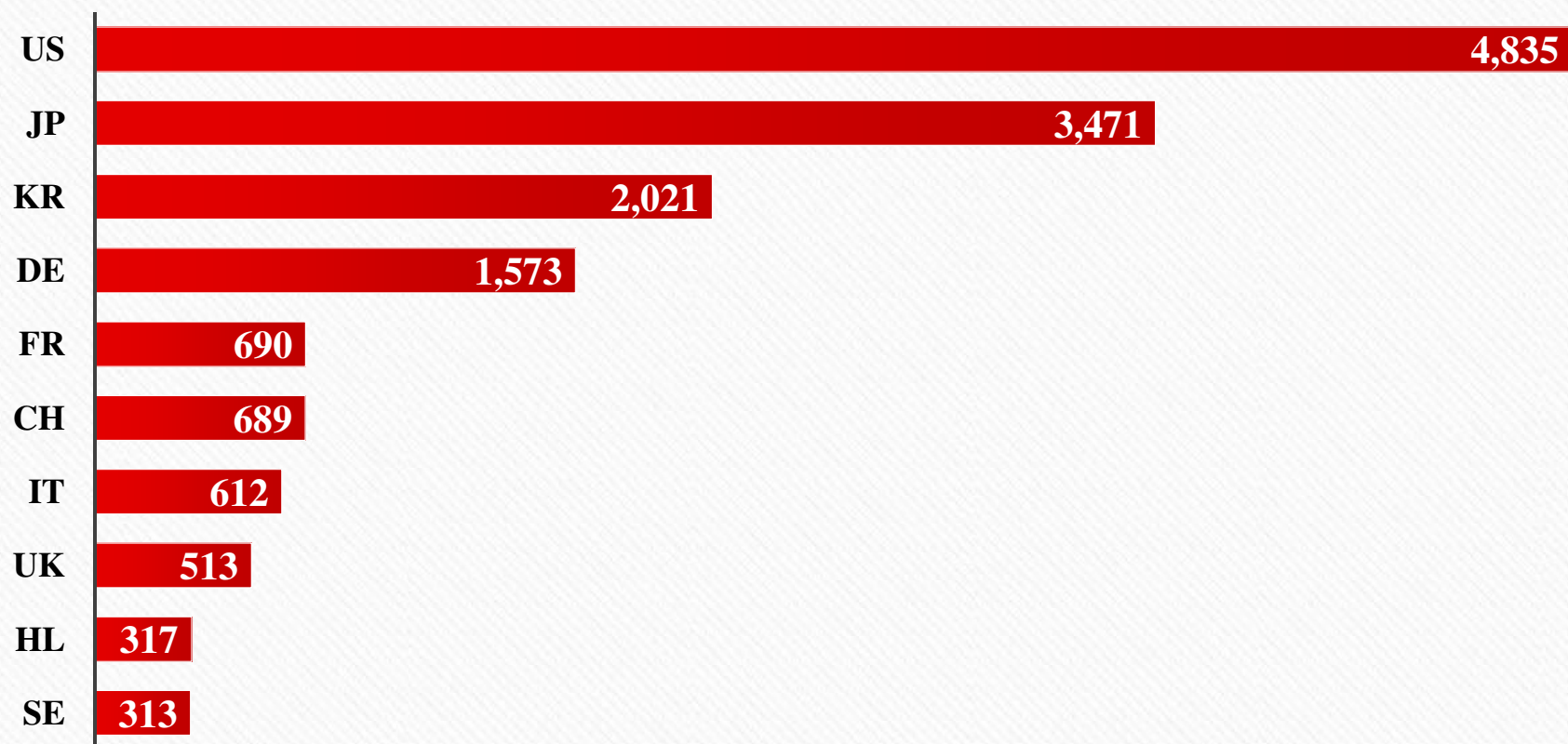

1. Latest Statistics on Design Patents

Design Patents Grant (2018-2022)

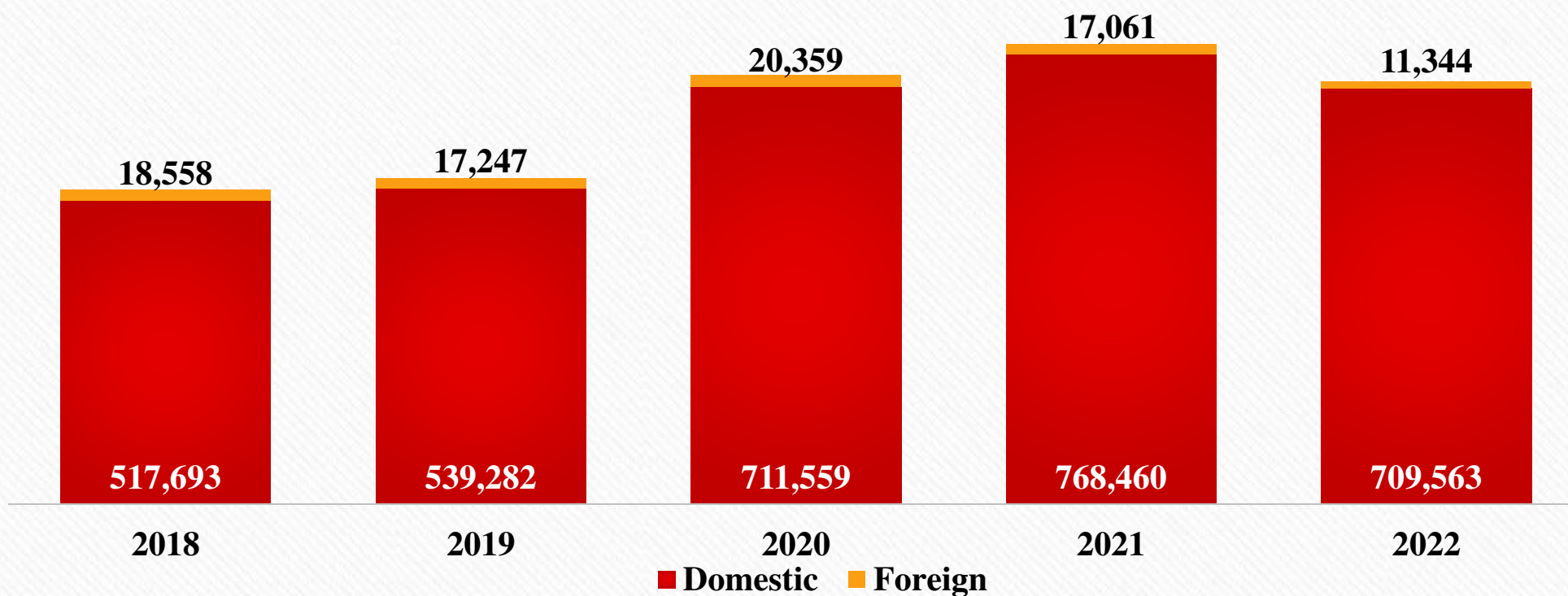

1. Latest Statistics on Design Patents

Valid Design Patents (2018-2022)

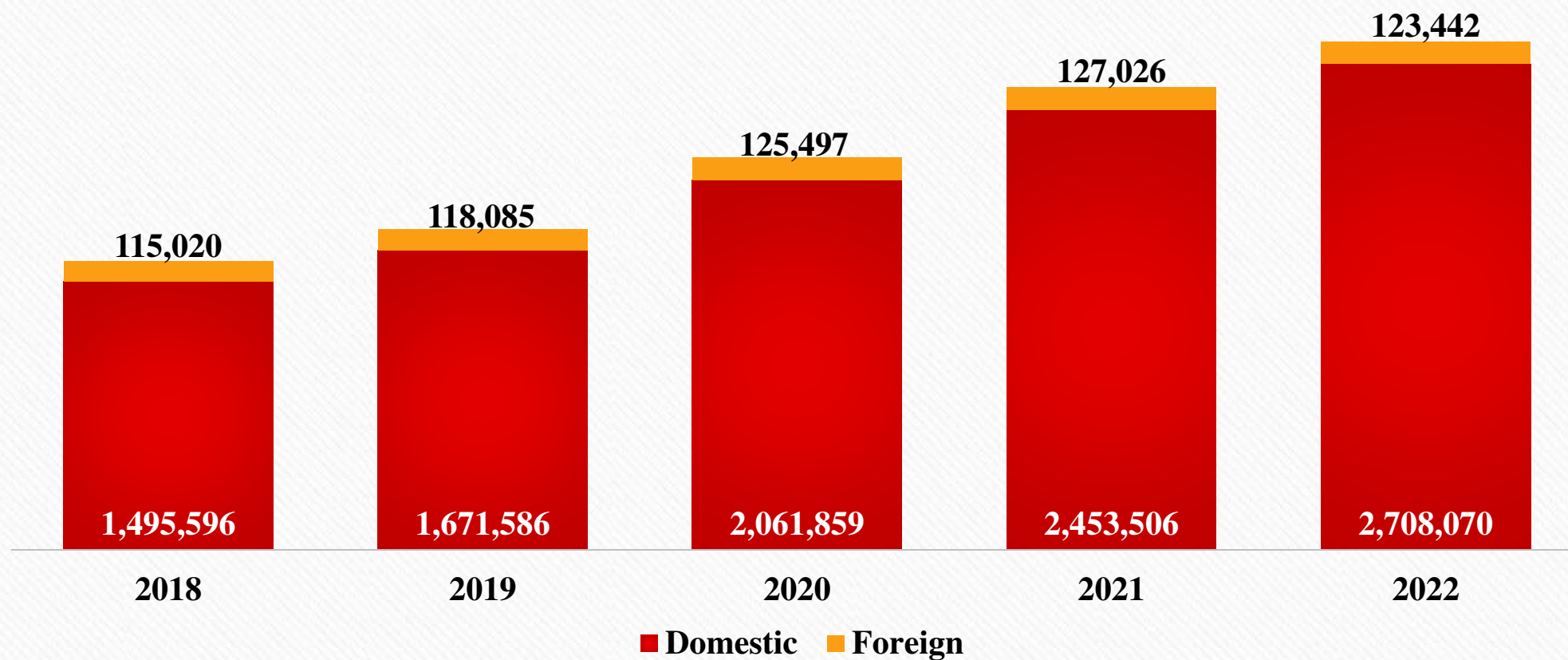

2. The Status of Hague International Applications

International Applications for the Top 10 Origins (2023.1-2023.9)

- Source: Hague Express, WIPO IP Statistics Data Center

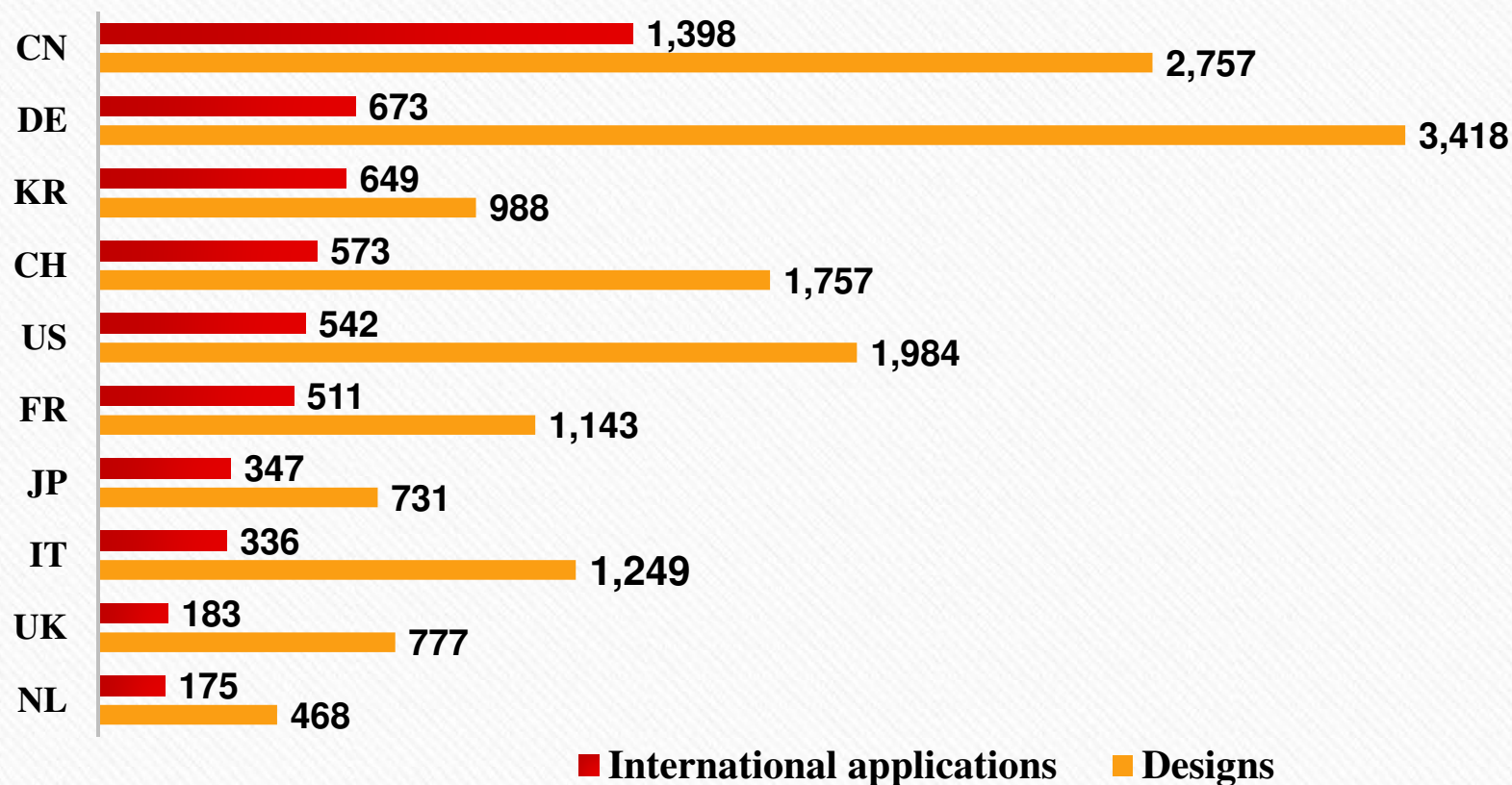

2. The Status of Hague International Applications

Who Designated China (by the number of designs, 2023.1-2023.9)

• Source: Hague Express, WIPO IP Statistics Data Center

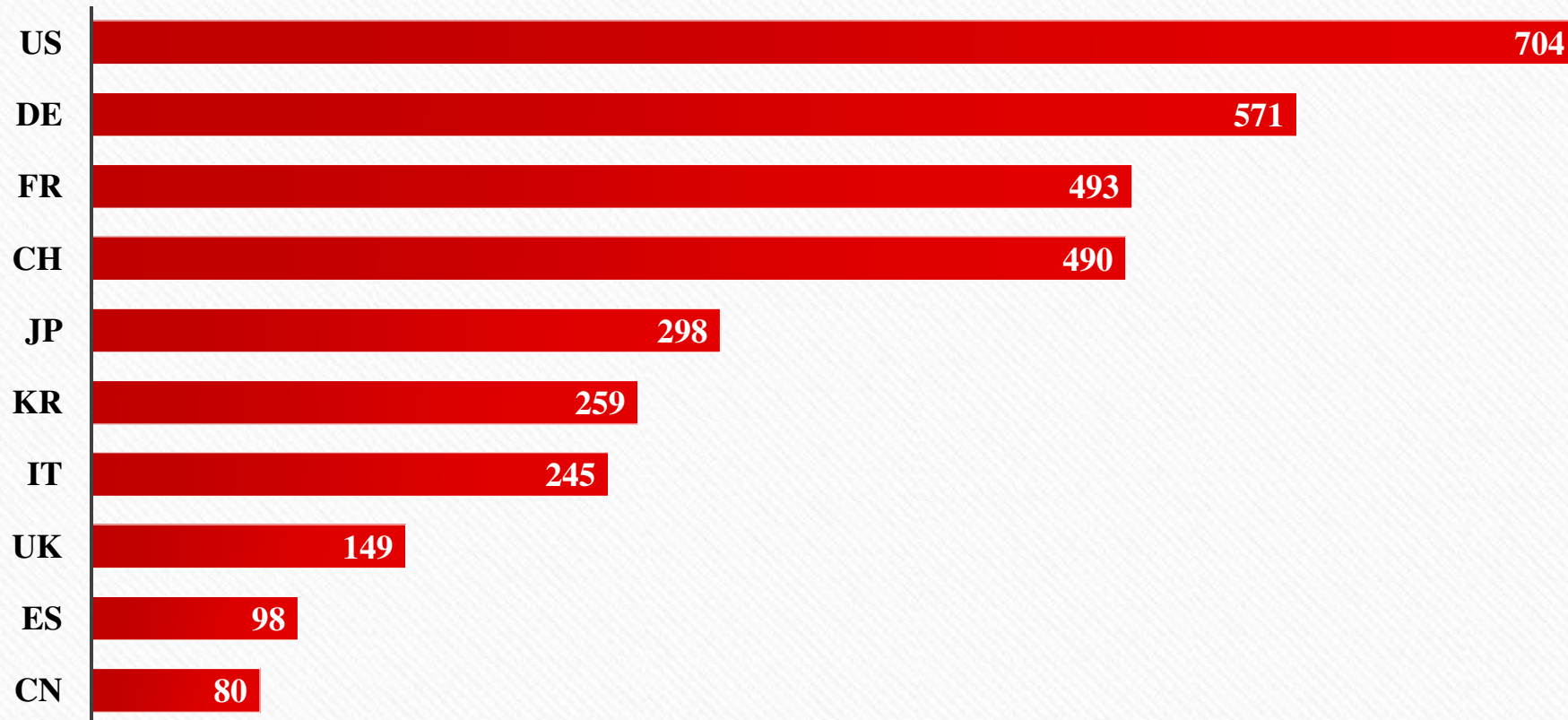

2. The Status of Hague International Applications

Designations (by Chinese users, 2023.1-2023.9)

- Source: Hague Express, WIPO IP Statistics Data Center

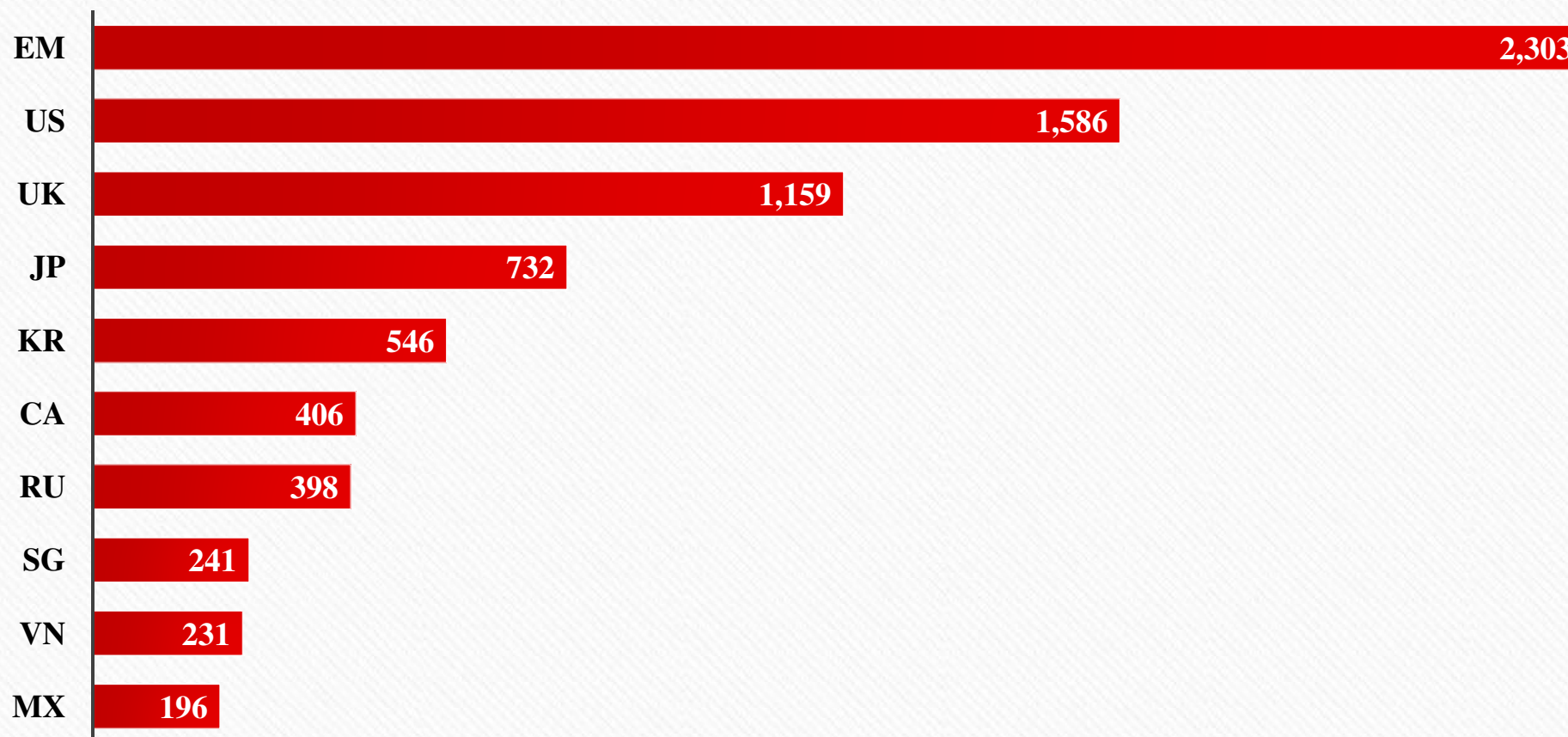



Amendment to Patent Law about Design

Amendment to Patent Law about Design

-  **Extend the Duration of Protection**
-  **Establish a Partial Design System**
-  **Establish a Domestic Priority System**
-  **Amend the Evaluation Report System**

Amendment to Patent Law about Design

- Extend the Duration of Protection

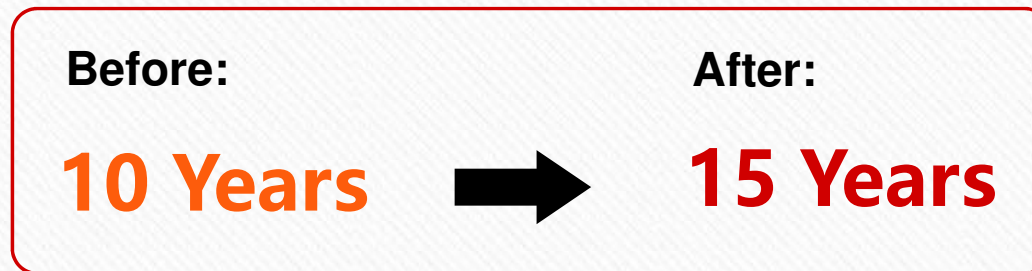

Article 42

Extend the duration of A Design Patent Right from 10 years to **15 years.**

Amendment to Patent Law about Design

- Establish a Partial Design System

Article 2.4

Amend the definition of *Design Patent*, establish a ***Partial Design System***.

Amendment to Patent Law about Design

Combination of broken lines and solid lines

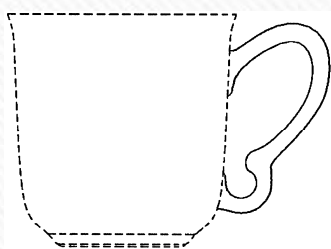

Front view

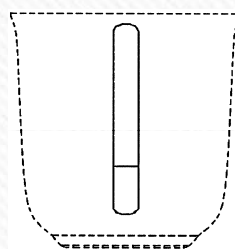

Right view

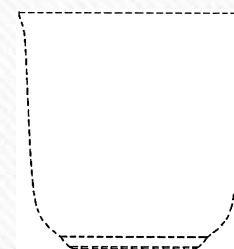

Left view

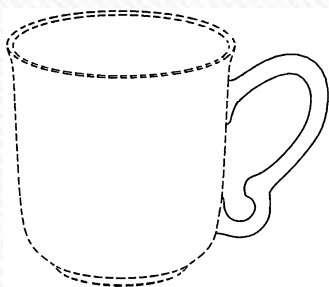

Perspective view

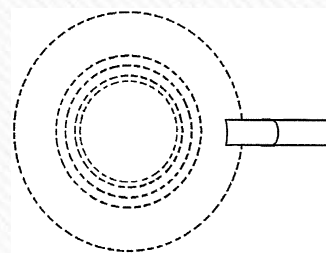

Top view

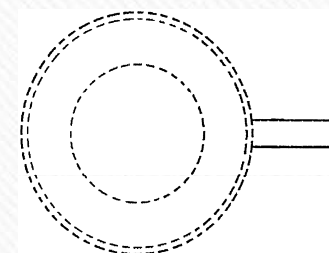

Bottom view

Amendment to Patent Law about Design

Cover with translucent overlay



Front view

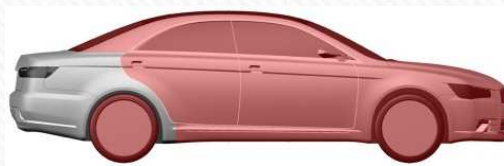

Back view



Top view



Left view



Right view



Perspective view 1



Perspective view 2

Brief Description: The part **doesn't covered by the red-translucent overlay** is sought for protection.

Amendment to Patent Law about Design

- Establish a Domestic Priority System

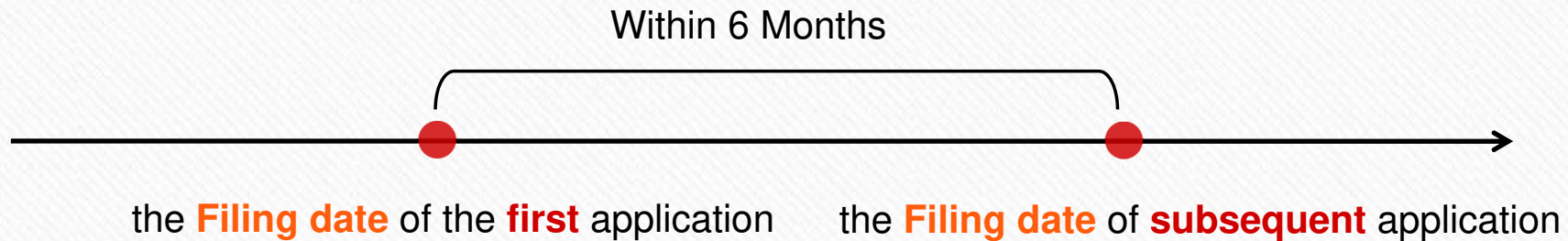

Article 29/Article 30

Amend the priority system, establish *a Design Domestic Priority System.*

Amendment to Patent Law about Design

Main Situations of Using Domestic Priority (1)



Previous application **A**



Subsequent design **B**



Subsequent application **C: A+B**

Amendment to Patent Law about Design

Main Situations of Using Domestic Priority (2)



Previous application A



Subsequent application B



Subsequent application **C: A+B**

Amendment to Patent Law about Design

Main Situations of Using Domestic Priority (3)

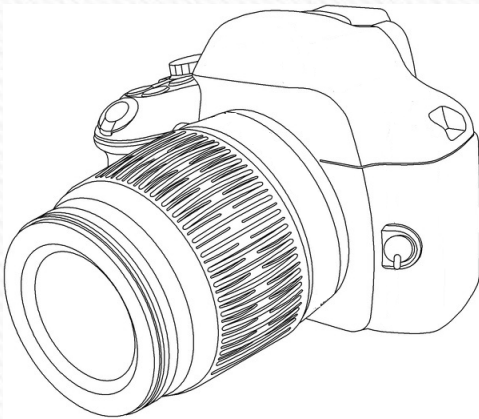

Previous application **A**
Product design as a **whole**

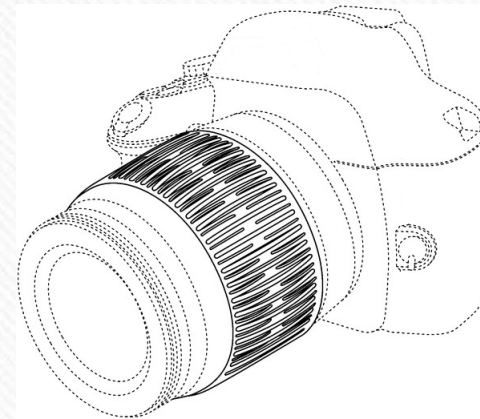

Subsequent application **B**
Partial design

Amendment to Patent Law about Design

Main Situations of Using Domestic Priority (4)

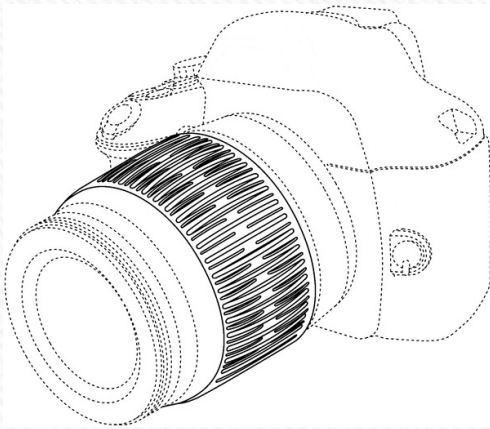

Previous application **A**

Partial design

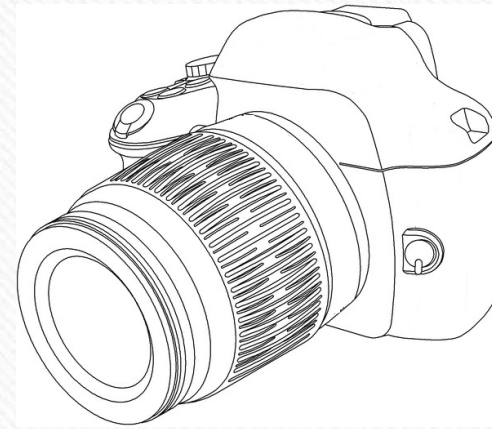

Subsequent application **B**

Product design as a **whole**

Amendment to Patent Law about Design

- Amend the Evaluation Report System

Before:



patentee or interested party

After:



patentee, interested party,
or alleged infringer

Article 66.2

Amend the *Evaluation Report System*, the **patentee, interested party, or alleged infringer** may submit an *Evaluation Report* on their initiative.



THANK YOU

CNIPA